

預賽：各組取 2 名晉級決賽

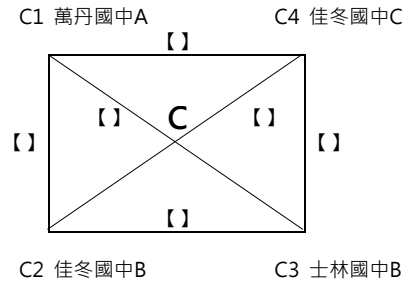

決賽：預賽同循環抽到不重抽

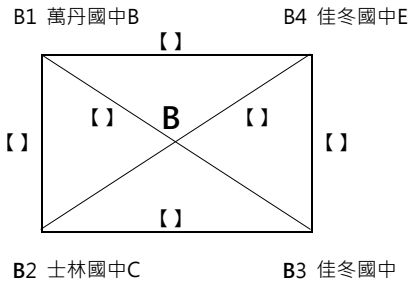

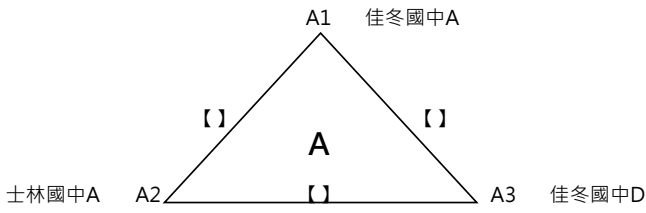
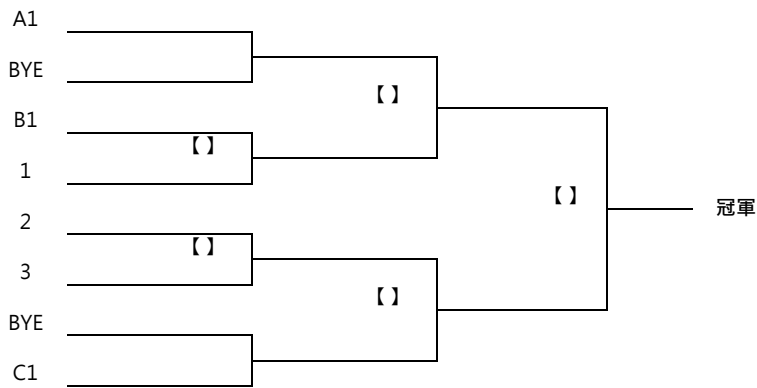
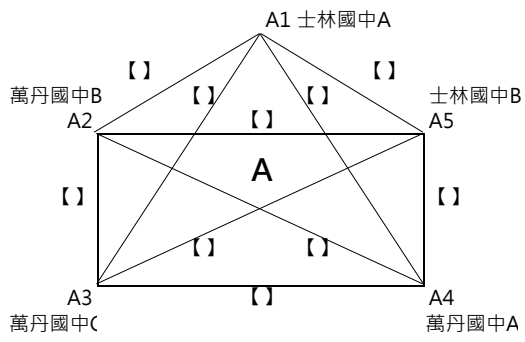

111年第二次全國藤球排名賽

男子乙組雙人賽

共14籤

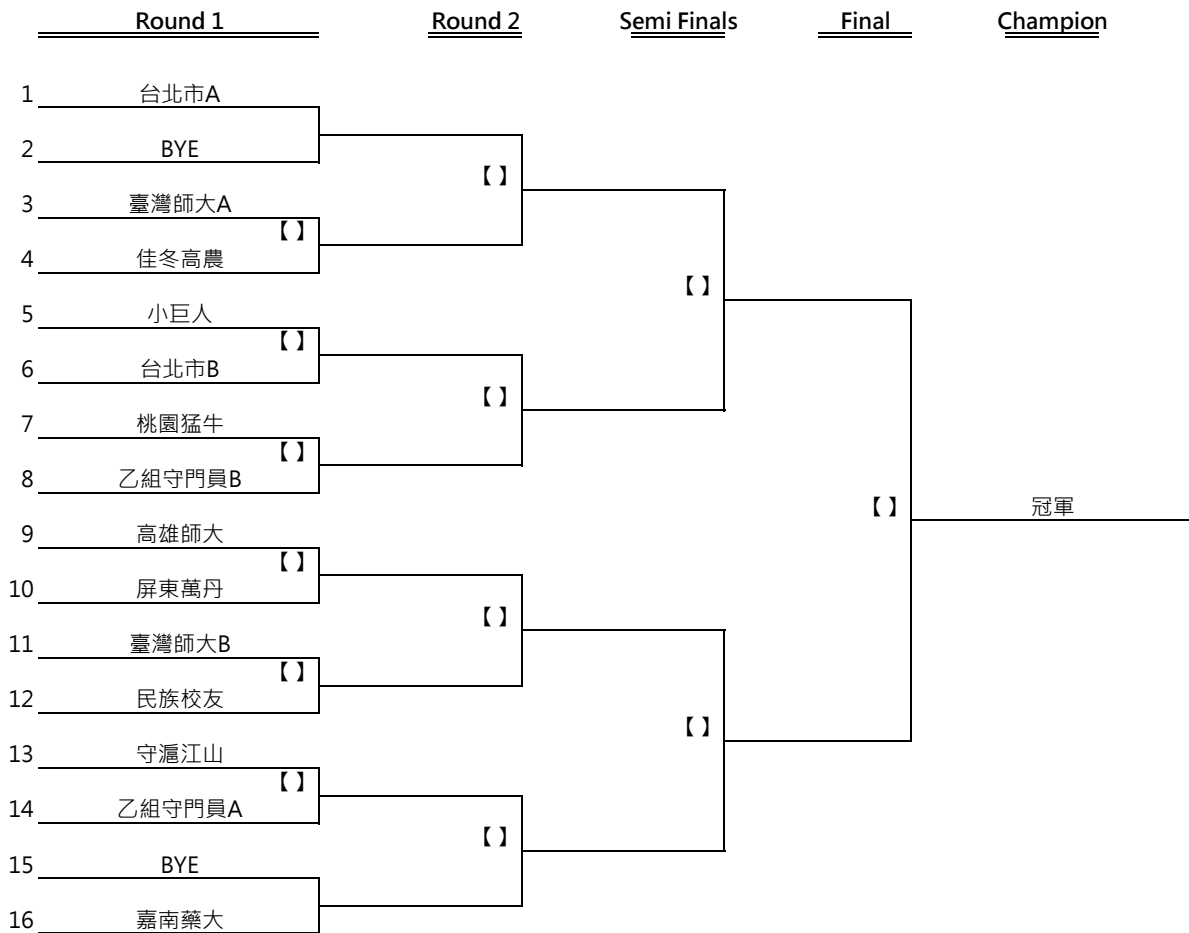

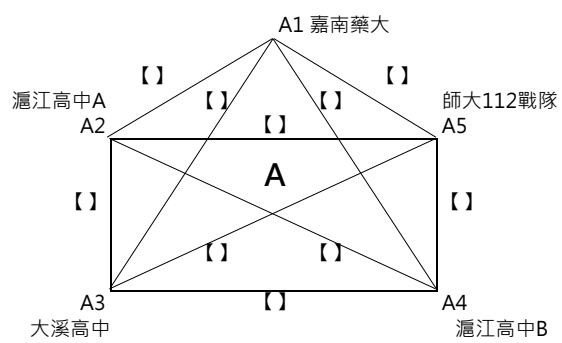

預賽：各組取 2 名晉級決賽

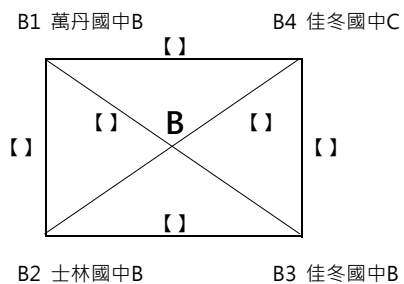
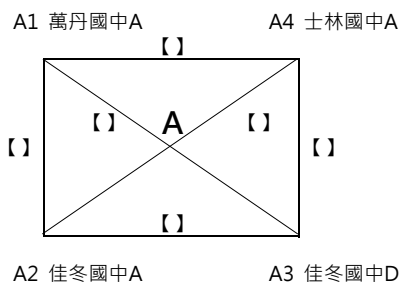

決賽：預賽同循環抽到不重抽

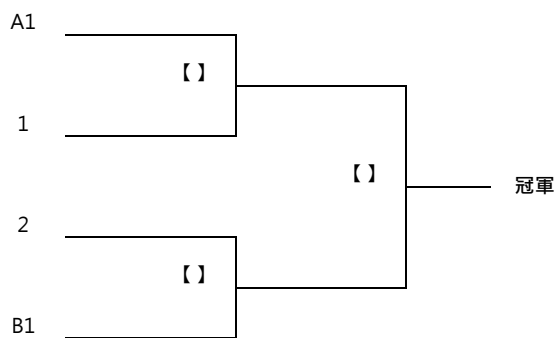

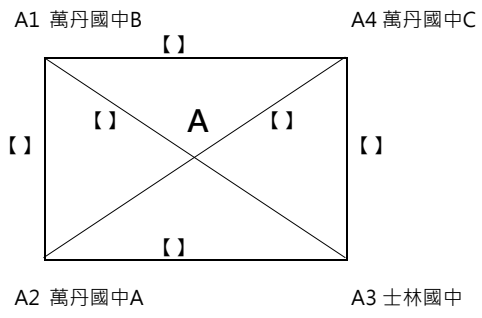

111年第二次全國藤球排名賽

男子乙組三人賽

共10籤

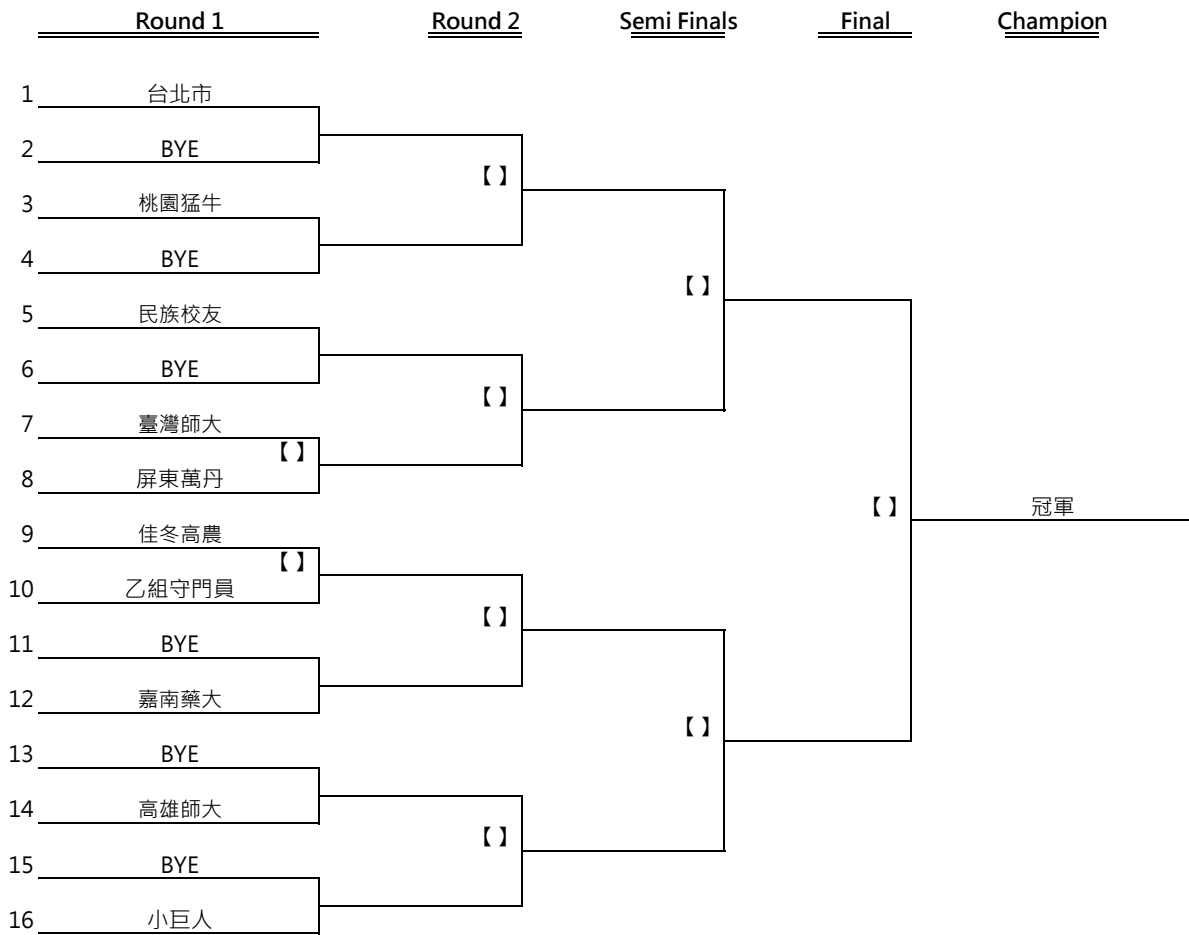

預賽：各組取 2 名晉級決賽

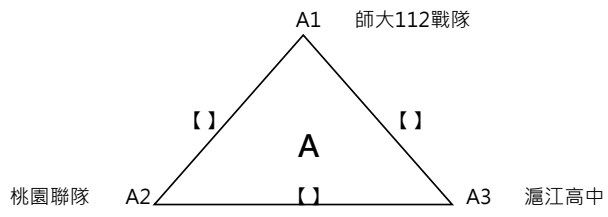

雙敗淘汰制·敗部不復活

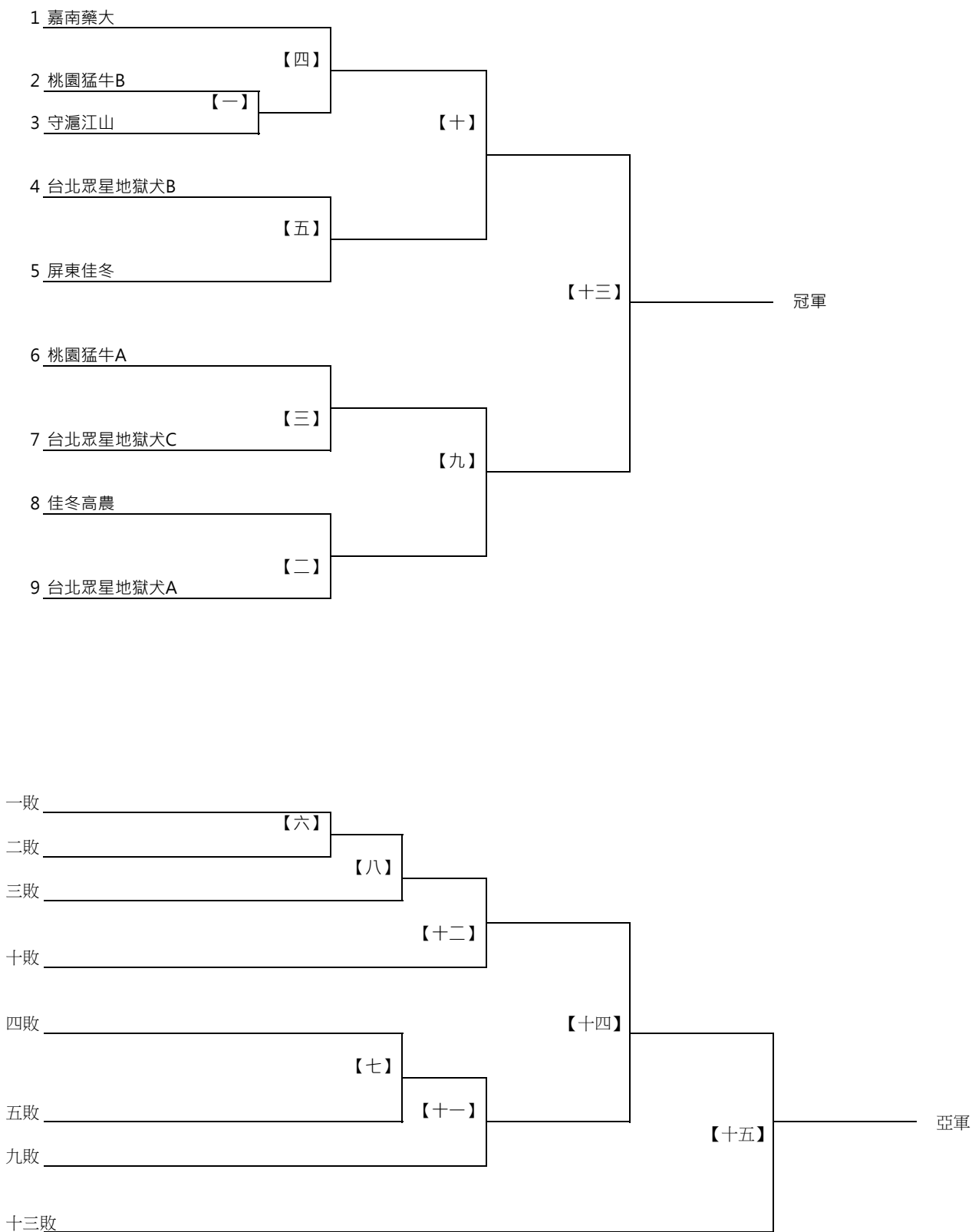

雙敗淘汰制·敗部不復活

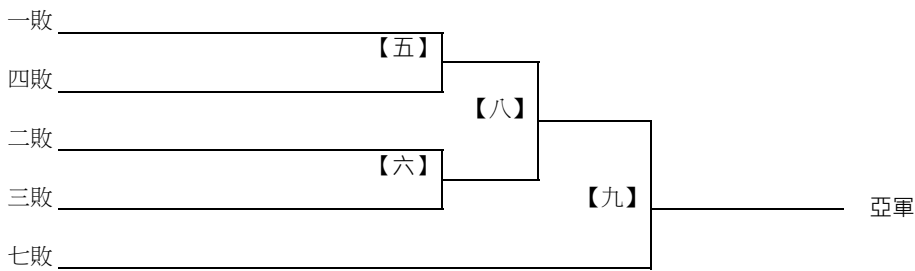
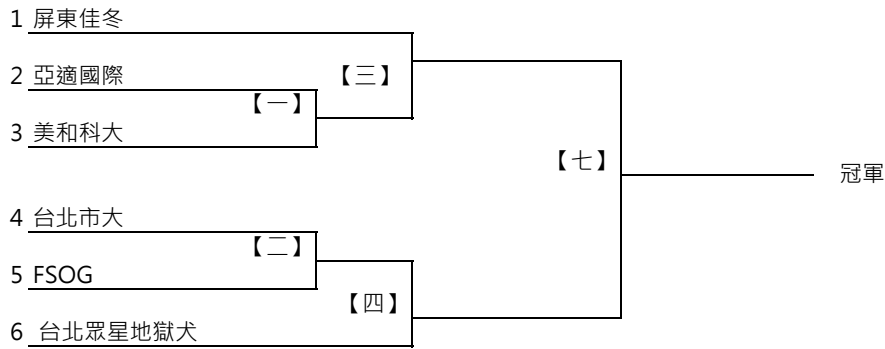

雙敗淘汰制·敗部不復活

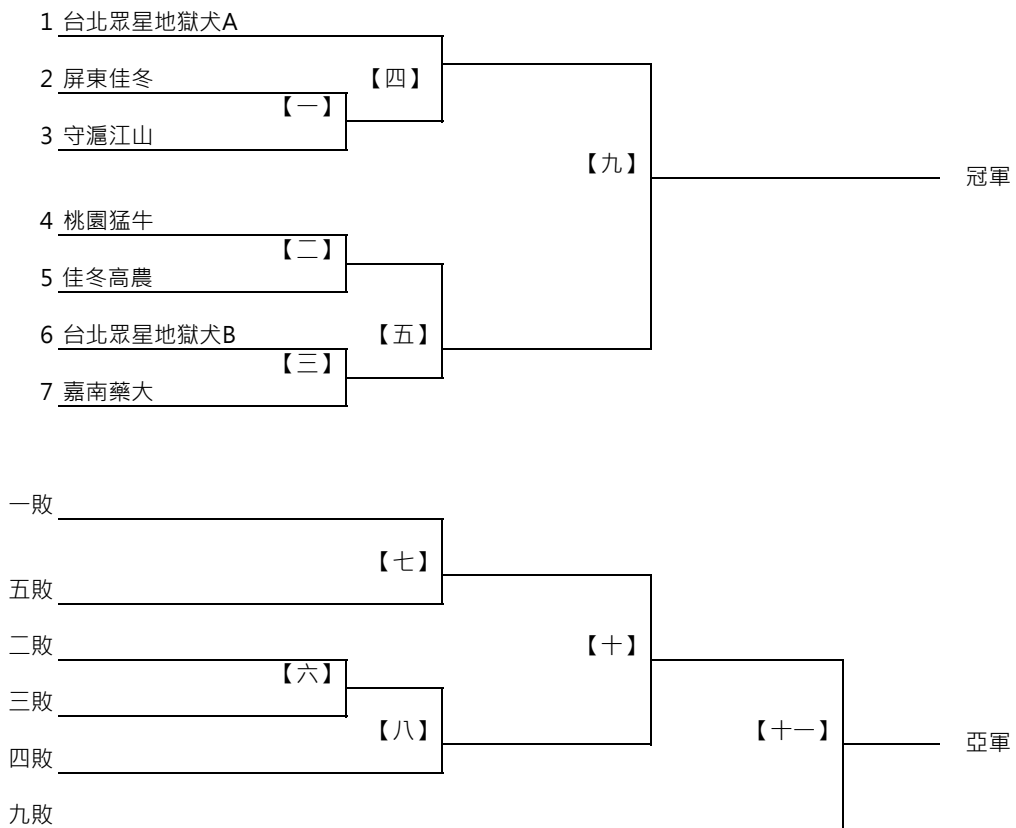

雙敗淘汰制·敗部不復活

